

Pen type, auto calibration

DISSOLVED OXYGEN METER

Model : PDO-519

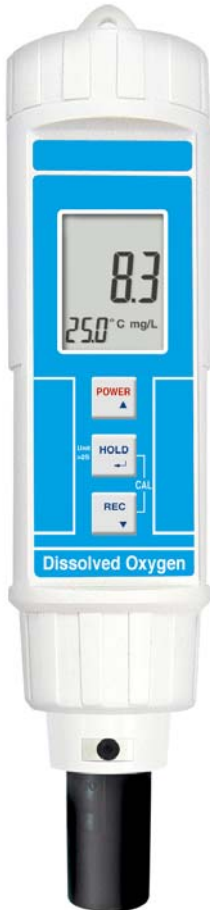

Your purchase of this DISSOLVED OXYGEN METER marks a step forward for you into the field of precision measurement. Although this METER is a complex and delicate instrument, its durable structure will allow many years of use if proper operating techniques are developed. Please read the following instructions carefully and always keep this manual within easy reach.



OPERATION MANUAL

ATTENTION :



Fill the Probe's Electrolyte at first.

Intend to keep the DO probe under the best condition, when user receive the DIGITAL OXYGEN METER along the PROBE, it should fill the Probe's Electrolyte at first.

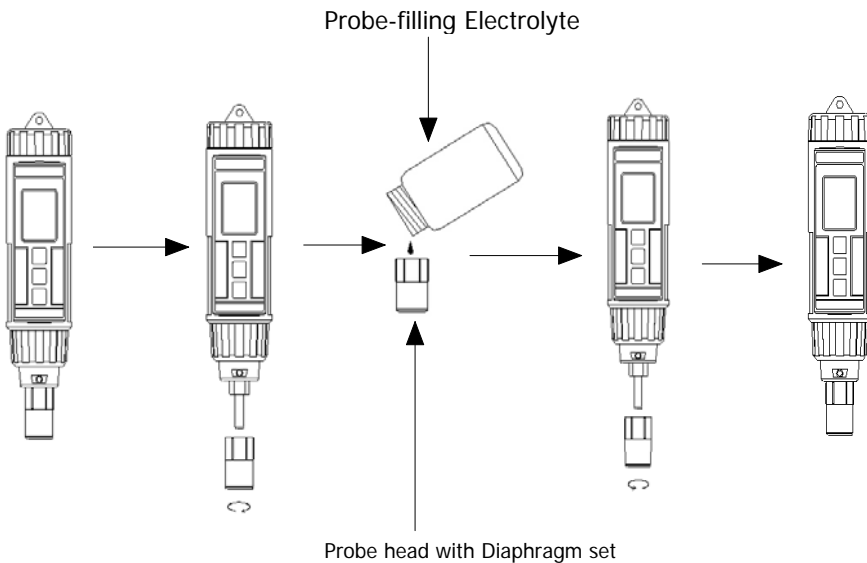

The procedures that to fill the Probe's Electrolyte, refer the chapter 5 " PROBE MAINTENANCE ", page 9.

TABLE OF CONTENTS

1. FEATURES.....	1
2. SPECIFICATIONS.....	2
3. FRONT PANEL DESCRIPTION.....	4
3-1 Display.....	4
3-2 Power button.....	4
3-3 HOLD button (Unit button).....	4
3-4 REC button (°C, °F button).....	4
3-5 Probe head with diaphragm set.....	4
3-6 Battery compartment/Cover.....	4
3-7 Protection cover for probe head.....	4
4. MEASURING PROCEDURE.....	5
4-1 Calibration.....	5
4-2 Dissolved Oxygen (DO) measurement	6
4-3 Oxygen in Air (O ₂) measurement	7
4-4 Temperature measurement.....	7
4-5 Data Hold.....	8
4-6 Data Record (Max., Min. reading).....	8
5. PROBE MAINTENANCE.....	9
6. BATTERY REPLACEMENT.....	11
7. OPTIONAL CARRYING CASE.....	11

1. FEATURES

- * This Digital Dissolved Oxygen Meter is supplied with a polarographic type probe with an incorporated Temp. sensor which serves for precise Dissolved Oxygen (DO) and Temp. measurement.
- * Applications for Aquarium, Medical research, Agriculture, Fish hatcheries, Laboratory, Water conditioning, Mining industry, Schools & Colleges, Quality control...
- * Heavy duty dissolved oxygen probe, probe head size can connect with BOD bottle
- * All in one Pen type Dissolved Oxygen Meter, easy operation.
- * Automatic Temp. compensation from 0 to 50 °C for sensor.
- * Microprocessor circuit assures high accuracy and provides special functions and features.
- * Multi-display, show Dissolved oxygen & Temp. at the same time.
- * Build in temperature °C, °F measurement.
- * Temperature unit can default to °C or °F.
- * LCD with two display, easy readout.
- * Auto power off to save the battery life.
- * IP-67 Water resistance.
- * Records Maximum and Minimum readings with recall.
- * Data hold function for freezing the desired value.
- * Use the durable, long-lasting components, including a heavy duty & compact ABS-plastic housing case.

2. SPECIFICATIONS

Display	LCD size : 29 mm x 28 mm. Dual function LCD	
Circuit	Custom one-chip of microprocessor LSI circuit.	
Measurement & Range	Dissolved Oxygen	0 to 20.0 mg/L (liter).
	Air Oxygen <i>* For reference only</i>	0 to 100.0 %.
	Temperature	0 to 50 °C .
Resolution	Dissolved Oxygen	0.1 mg/L.
	Oxygen in Air	0.1 % O ₂ .
	Temperature	0.1 °C .
Accuracy (23± 5 °C)	Dissolved Oxygen	± 0.4 mg/L.
	Oxygen in Air <i>* For reference only</i>	± 0.7% O ₂ .
	Temperature	± 0.8 °C/1.5 °F.
Sensor Structure	The polarographic type oxygen probe with an incorporated temperature sensor.	
Temp. Compensation	0 to 50 °C , <i>* Automatic adjustment</i>	
Memory Recall	Records Maximum, Minimum readings with recall.	
Power off	Auto power off saves battery life, or manual off by push button.	
Data Hold	Freeze the display reading.	
Sampling Time of display	Approx. 1 second.	
Operating Temperature	0 to 50 °C .	
Operating Humidity	Less than 80% RH.	
Power Supply	DC 1.5V battery (UM-4/AAA) x 4 PCs.	
Power Current	Approx. DC 6.2 mA.	
Weight	176 g/0.39 LB. <i>* Include probe and battery.</i>	

Protection	IP-65 : 0 to 50 °C. IP-67 : 0 to 30 °C.
Dimension	180 x 40 x 40 mm (7.1 x 1.6 x 1.6 inch).
Accessories Included	Soft carrying case (CA-05A).....1 PC. Operation manual..... 1 PC. Spare Probe head with Diaphragm OXHD-04.....2 set Probe-filling Electrolyte OXEL-03.....1 set
Optional probe and accessories	* Spare Probe head with Diaphragm set.....OXHD-04 * Probe-filling Electrolyte..... OXEL-03 * Hard carrying case.....CA-06

3. FRONT PANEL DESCRIPTION

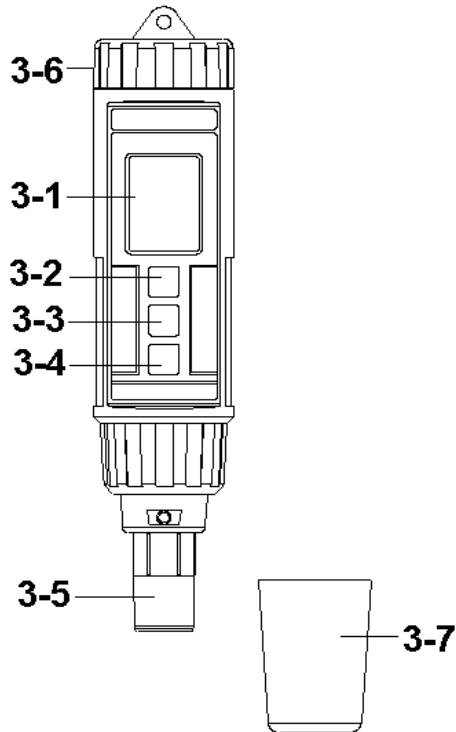

Fig. 1

- 3-1 Display
- 3-2 Power button
- 3-3 HOLD button (Unit button)
- 3-4 REC button (°C, °F button)
- 3-5 Probe head with diaphragm set
- 3-6 Battery compartment/Cover
- 3-7 Protection cover for probe head

4. MEASURING PROCEDURE

4-1 Calibration

Before the measurement, the meter should be processed the following calibration procedures :

1) Move the " Protection cover " (3-7, Fig. 1) away from the " Probe head " (3-5, Fig. 1).

Power on the instrument by pushing the " Power Off/On button " (3-2, Fig. 1).

The " Display " (3-1, Fig. 1) will show the " O2% " and the " Temp. " value as example :

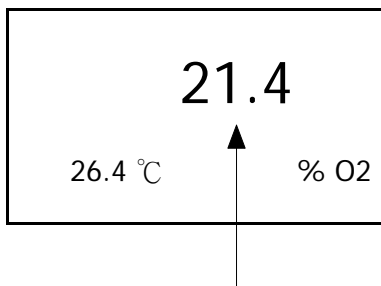

The upper display (%O2 display) value will be changed, wait for approx. 3 minutes at least until the upper display reading values become stable & no fluctuation.

Press the " HOLD button " (3-3, Fig. 1) once, the " Display " (3-1, Fig. 1) will show the " Hold " indicator, then following press the " REC button " (3-4, Fig. 1) once, the Display will show :

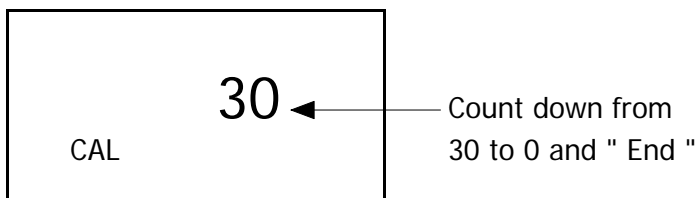

The text " CAL " will flash, the upper value will count down from 30 to 0 and " End " , then show as :

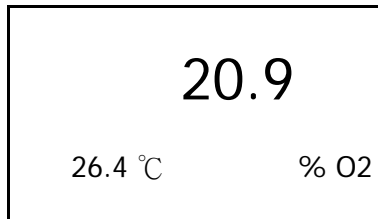

The upper display will show the values exactly same as 20.9 or 20.8. (As the oxygen in air is 20.9 % typically, so use the environment air O2 value for quick & precise calibration).

Now the calibration procedures are finished !

Calibration Consideration :

Please process calibration procedures under wide and ventilating environment for best effect.

4-2 Dissolved Oxygen (DO) measurement

- 1) After the meter be calibrated (above procedure 4-1), the meter is ready for measurement.
- 2) Press the " Unit button " (3-3, Fig. 1) continuously at least two seconds, the display indicator will change from " % O2 " change to " mg/L ", now the meter is ready for Dissolved Oxygen (DO) measurement.
- 3) * Immersed the " Probe head " (3-5, Fig. 1) to the measured liquid (sample) completely in order for the probe to be influenced by the automatic temperature compensation circuit, refer to Fig. 2, page 7.

- * As for the thermal equilibrium to occur between the probe & the measurement sample (liquid) must be taken, it will take a few minutes typically.

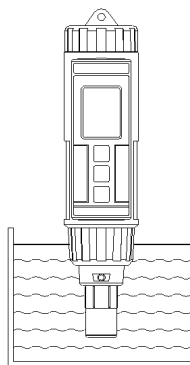

Fig. 2

- 4) * In order to measure the dissolved oxygen content in any given liquid, it is sufficient to immerse the tip of the probe in the solution, making sure that velocity of the liquid coming into contact with the probe is at least 0.2 - 0.3 m/s or to shake the probe.
 - * During laboratory measurements, the use of a magnetic agitator to ensure a certain velocity in the fluid is recommended. In this way, errors due to the diffusion of the oxygen present in the air in the solution are reduced to a minimum.
- 5) Rinsed the probe accurately with normal tap water after each series of measurement.
 - Install " Probe head protection cover " (3-7, Fig. 2) into the " Probe head " (3-5, Fig. 2).

4-3 Oxygen in Air (O₂) measurement

After the meter be calibrated (above procedure 4-1), the meter is ready for O₂ (Oxygen in air) measurement, the display will show the indicator " O₂% " .

* *The Air oxygen measurement value is for reference only.*

4-4 Temperature measurement

During the measurement, the lower LCD Display will show the temperature values of measuring solution.

The method to change the Temp. unit from " °C " to " °F " or " °F " to " °C " are :

- a. When intend to change the Temp. unit, it should can not execute the " Record " function, the display should not show " REC " indicator.
- b. Press the " REC button (°C, °F button) " (3-4, Fig. 1) continuously at least two seconds, the Temp. unit will change from " °C " to " °F " or " °F " to " °C " with default, then release the finger from the button.

4-5 Data Hold

During the measurement, press the " Hold button " (3-3, Fig. 1) once will hold the measured value & the LCD will display a " HOLD " symbol.

** Press the " Hold button " once again will release the data hold function.*

4-6 Data Record (Max., Min. reading)

- * The data record function records the maximum and minimum readings. Press the " REC button " (3-4, Fig. 1) once to start the Data Record function and there will be a " REC " symbol on the display.
- * With the " REC " symbol on the display :
 - a) Press the " REC button " (3-4, Fig. 1) once, the " REC MAX " symbol along with the maximum value will appear on the display.
If intend to delete the maximum value, press the " Hold button " (3-3, Fig. 1) once, the display will show the " REC " symbol only & execute the memory function continuously.
 - b) Press the " REC button " (3-4, Fig. 1) again, the " REC MIN. " symbol along with the minimum value will appear on the display.
If intend to delete the minimum value, press the " Hold button " (3-3, Fig. 1) once, then the display will show the " REC " symbol only & execute the memory function continuously.
 - c) To exit the memory record function, just press the " REC " button for 2 seconds at least. The display will revert to the current reading.

5. PROBE MAINTENANCE

User first time to use the meter :

Intend to let the DO probe keep the best condition. When user receive the DIGITAL OXYGEN METER along the PROBE, it should fill the Probe's Electrolyte at first.

User already use the meter for a certain period :

Whenever user can not calibrate the meter properly or the meter's reading value is not stable, please check the oxygen probe to see if the electrolyte in the probe head container is run out or the diaphragm (probe head with diaphragm set) exist problem (dirty). If yes, please fill the electrolyte or change the " Probe head with diaphragm set " and make the new calibration.

The consideration of Diaphragm (probe head with diaphragm set) :

The oxygen probe component is the thin Teflon diaphragm housed in the tip of the probe. The diaphragm is permeable by the oxygen molecules but not by the considerably larger molecules contained in the electrolyte. Due to this characteristic, the oxygen may diffuse throughout the electrolyte solution contained in the probe, and its concentration may be quantified by the measurement circuit.

This sensitive diaphragm is rather delicate & is easily damaged if it comes into contact with solid objects or is subjected to blows. If the diaphragm is damaged or the electrolyte is run out, it must be replaced in the following way :

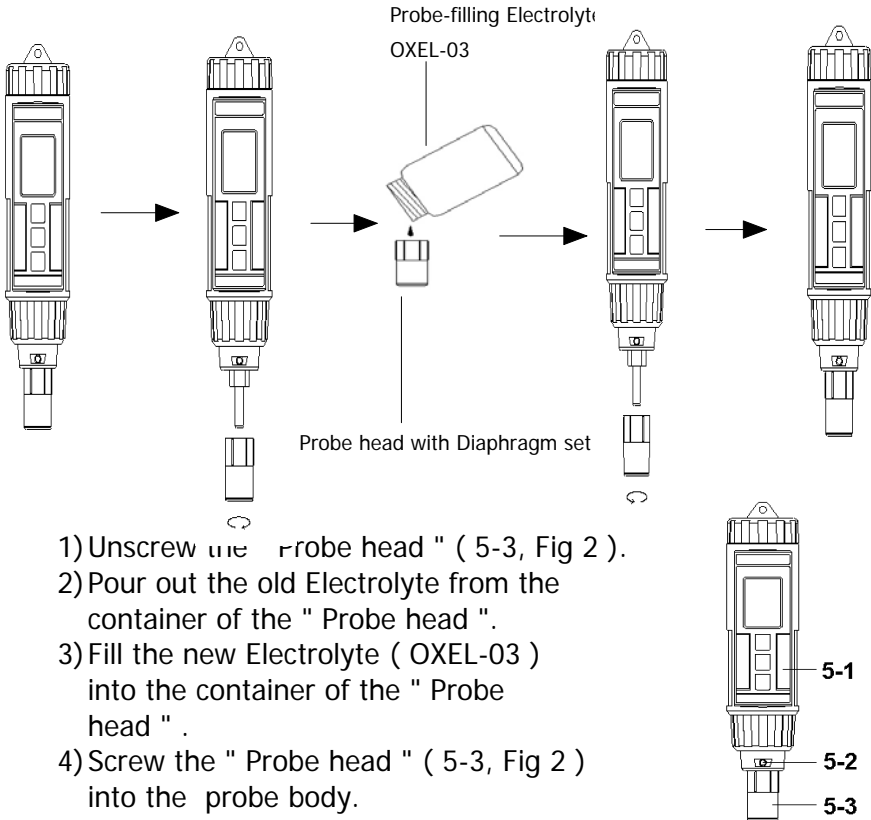



Fig. 2

5-1 Probe handle
5-2 Temp. sensing metal
5-3 Probe head

6. BATTERY REPLACEMENT

- 1) When the LCD display show " , it is necessary to replace the battery. However, in-spec measurement may still be made for several hours after Low Battery Indicator appears before the instruments instrument become inaccurate.
- 2) To replace the battery, rotate and remove the " Battery Cover " (3-1, Fig. 1), take out the old batteries, install new batteries :
DC 1.5V battery (UM-4/AAA) x 4 PCs.
- 3) **When install the batteries, should make attention the battery polarity.**
- 4) After install the batteries, reinstall the battery cover again.

7. OPTIONAL CARRYING CASE

Carrying case
CA-06

Hard carrying case.
(280 x 195 x 65 mm)

